

LED Driver

- Supplies stable bias current even at low battery voltage
- Ideal for stabilizing bias current of LEDs
- Negative temperature coefficient protects LEDs against thermal overload
- Suitable for 12 V automotive applications
- Pb-free (RoHS compliant) package
- Qualified according AEC Q101

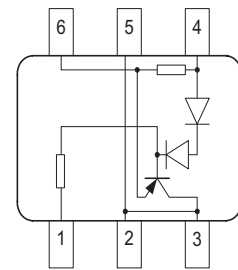
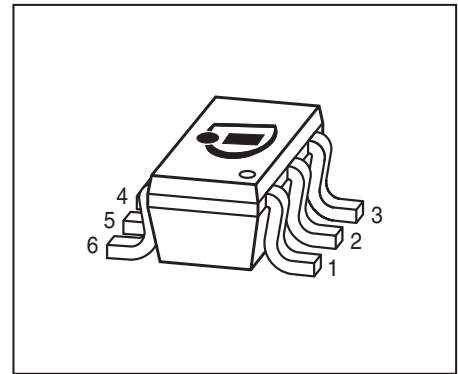

Type	Marking	Pin Configuration				Package
BCR401U	L1s	1 = GND	2;3;5 = I _{OUT}	4 = V _S	6 = R _{EXT}	SC74

Maximum Ratings

Parameter	Symbol	Value	Unit
Source voltage	V _S	40	V
Output current V _S = 10 V, V _{out} = 8.6 V	I _{out}	65	mA
Output voltage	V _{out}	38	V
Reverse voltage between all terminals	V _R	0.5	
Total power dissipation, T _S = 102 °C	P _{tot}	500	mW
Junction temperature	T _j	150	°C
Storage temperature	T _{stg}	-65 ... 150	

Thermal Resistance

Parameter	Symbol	Value	Unit
Junction - soldering point ¹⁾	R _{thJS}	≤ 50	K/W

¹⁾For calculation of R_{thJA} please refer to Application Note Thermal Resistance

Electrical Characteristics at $T_A=25^\circ\text{C}$, unless otherwise specified

Parameter	Symbol	Values			Unit
		min.	typ.	max.	
Characteristics					
Collector-emitter breakdown voltage $I_C = 1 \text{ mA}$, $I_B = 0$	$V_{BR(CEO)}$	40	-	-	V
Supply current $V_S = 10 \text{ V}$	I_S	340	420	500	μA
DC current gain $I_C = 50 \text{ mA}$, $V_{CE} = 1 \text{ V}$	h_{FE}	100	220	470	-
Internal resistor $I_{Rint} = 10 \text{ mA}$	R_{int}	72	91	110	Ω
Output current $V_S = 10 \text{ V}$, $V_{out} = 8.6 \text{ V}$	I_{out}	9	10	11	mA
Voltage drop ($V_S - V_E$) $I_{out} = 10 \text{ mA}$	V_{drop}	0.82	0.91	1.0	V
DC Characteristics with stabilized LED load					
Lowest sufficient battery voltage overhead $I_{out} > 18 \text{ mA}$	V_{Smin}	-	1.4	-	V
Output current change versus T_A $V_S = 10 \text{ V}$	$\Delta I_{out}/I_{out}$	-	-0.2	-	%/K
Output current change versus V_S $V_S = 10 \text{ V}$	$\Delta I_{out}/I_{out}$	-	1	-	%/V

Total power dissipation $P_{tot} = f(T_S)$

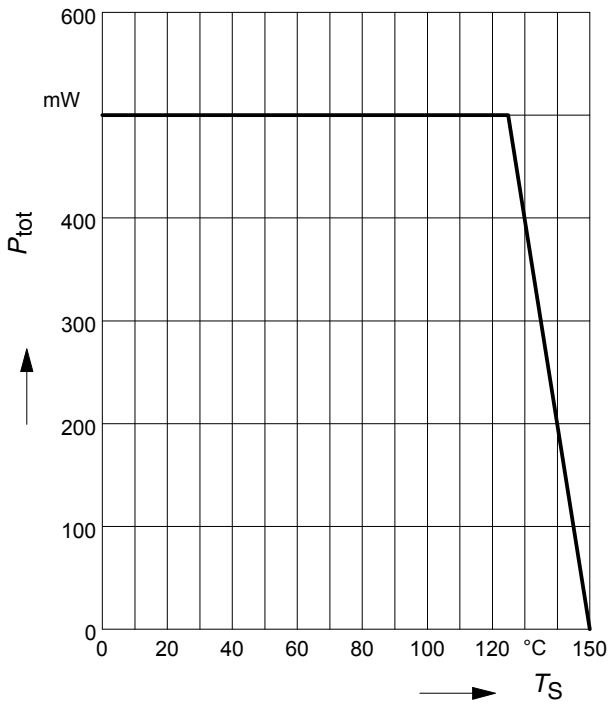

Permissible Pulse Load $R_{thJS} = f(t_p)$

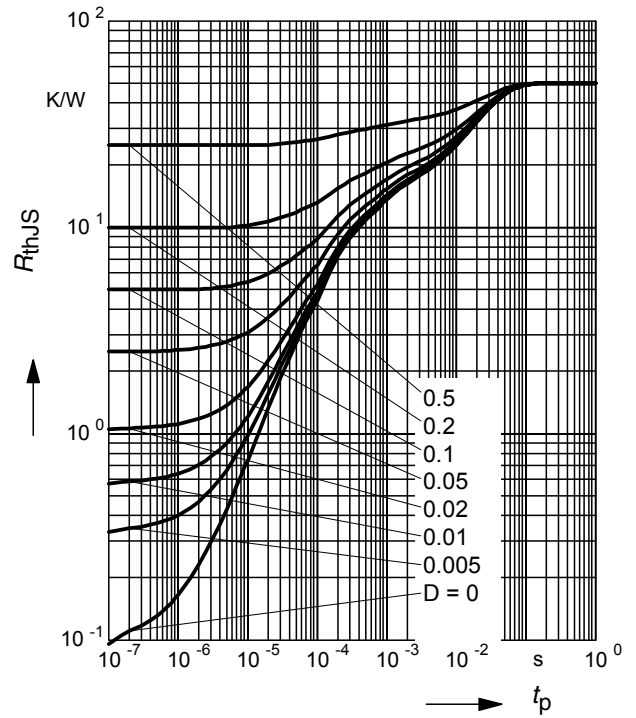

Permissible Pulse Load

$P_{totmax} / P_{totDC} = f(t_p)$

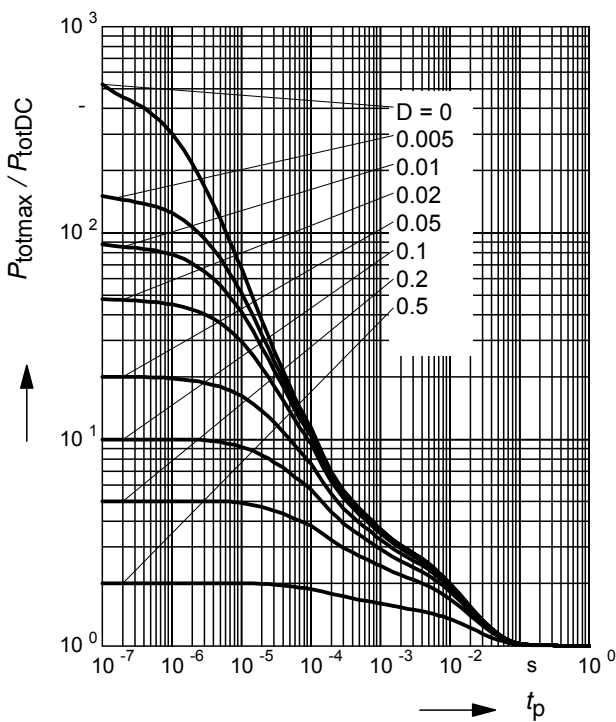

Output current versus supply voltage

$I_{out} = f(V_S); R_{ext} = \text{Parameter}$

$V_S - V_{out} = 1.4 \text{ V}$

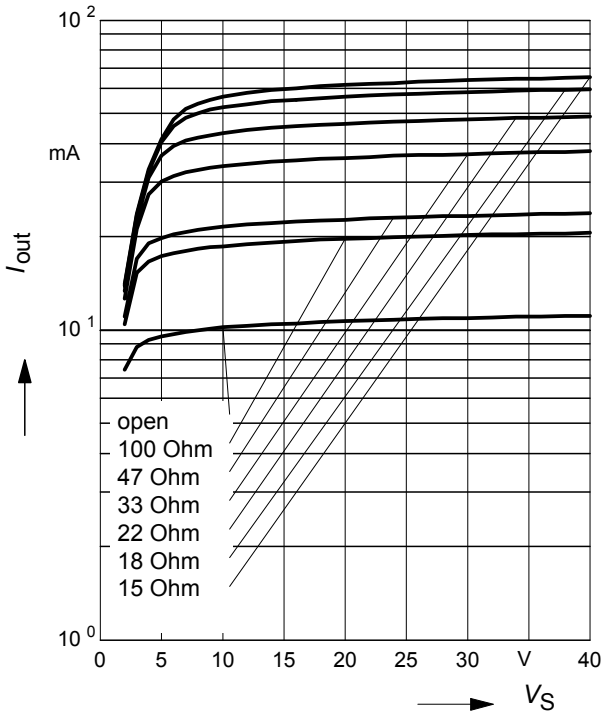

Supply current versus supply voltage

$I_S = f(V_S)$

$T_A = \text{Parameter}$

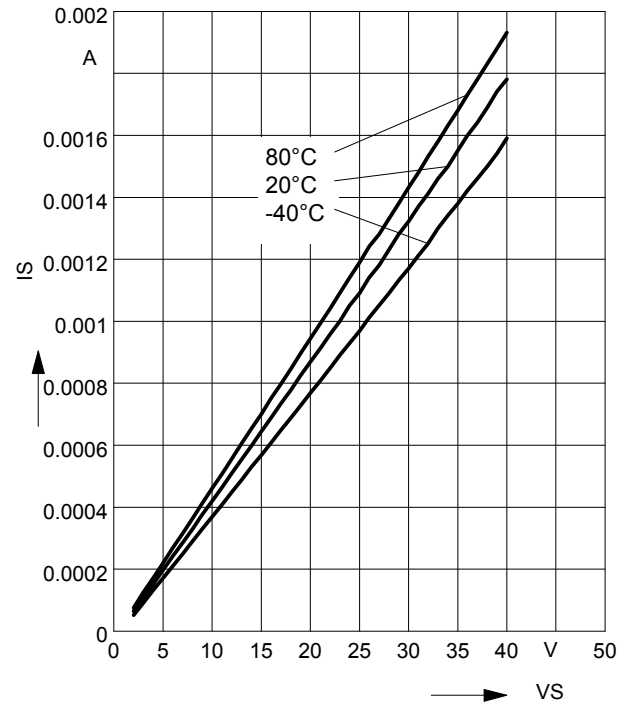

Output current versus supply voltage

$I_{out} = f(V_S), T_A = 20^\circ\text{C}$

$V_S - V_{out}$ as Parameter

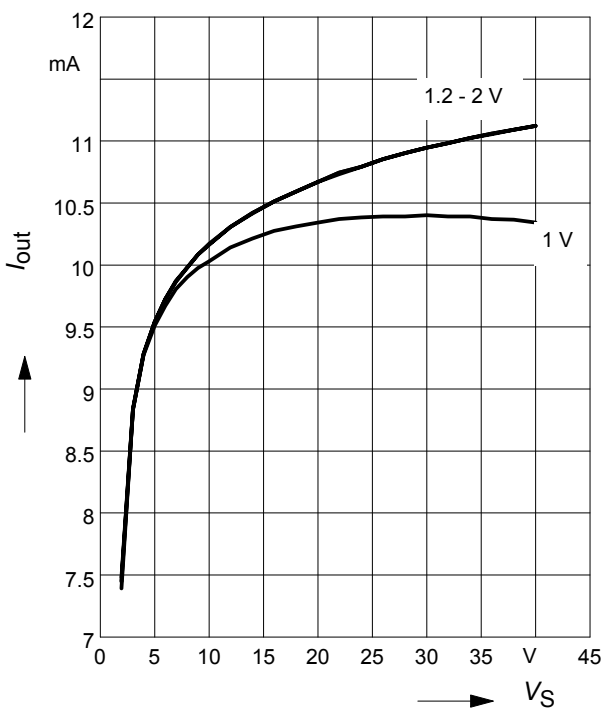

Output current versus supply voltage

$I_{out} = f(V_S), V_S - V_{out} = 1.4 \text{ V}$

$T_A = \text{Parameter}$

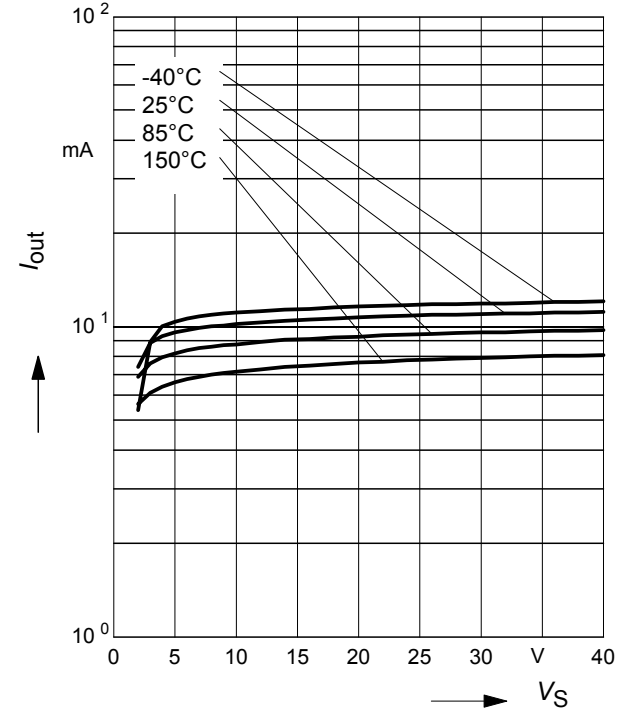

Output current versus external resistor

$I_{out} = (R_{ext}), V_S = 10V, V_S - V_{out} = 1.4 V$

$T_A = \text{Parameter}$

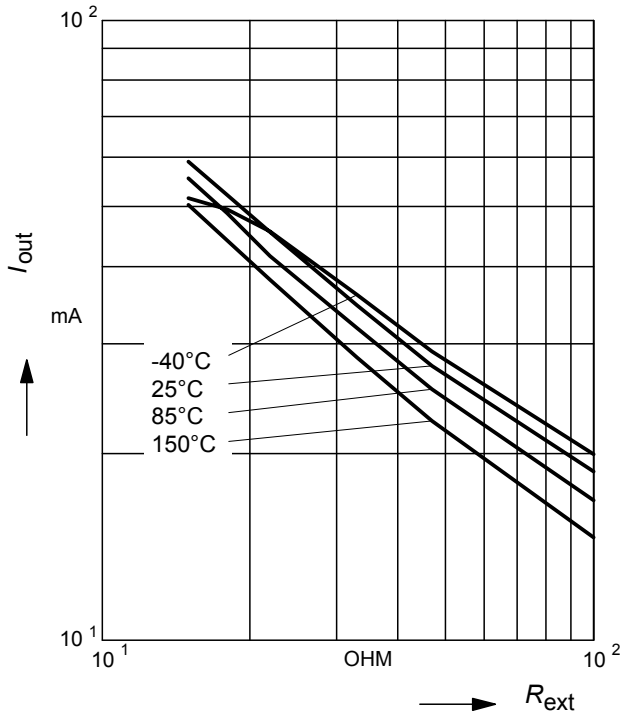

Application Circuit

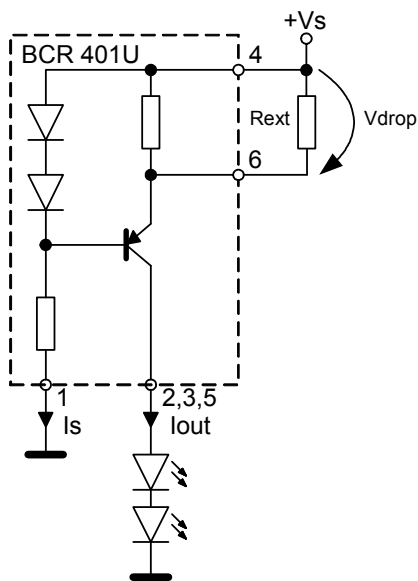

Package Outline

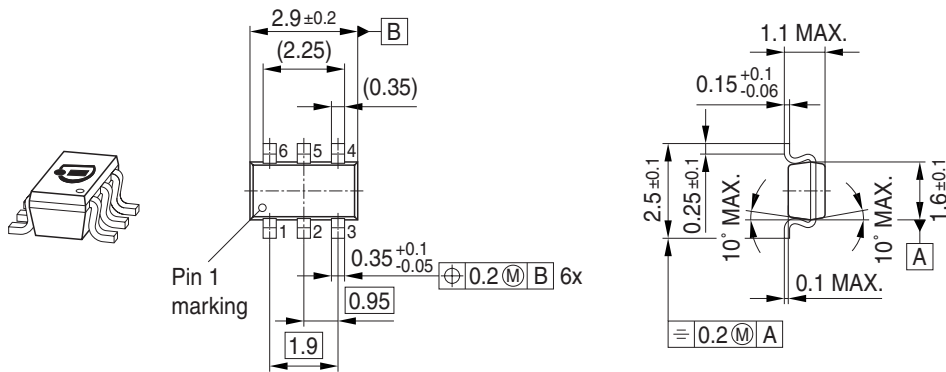

Foot Print

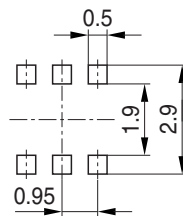

Marking Layout (Example)

Small variations in positioning of Date code, Type code and Manufacture are possible.

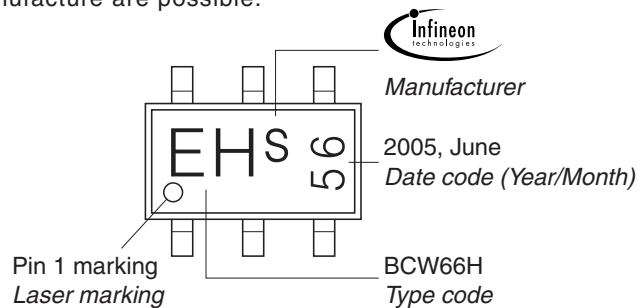

Standard Packing

Reel \varnothing 180 mm = 3.000 Pieces/Reel
 Reel \varnothing 330 mm = 10.000 Pieces/Reel

For symmetric types no defined Pin 1 orientation in reel.

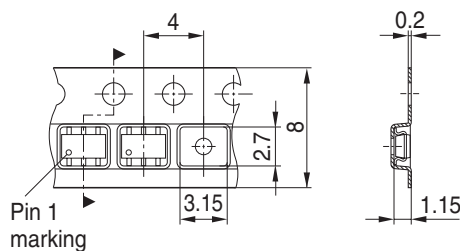

Published by
Infineon Technologies AG
81726 München, Germany
© Infineon Technologies AG 2007.
All Rights Reserved.

Attention please!

The information given in this data sheet shall in no event be regarded as a guarantee of conditions or characteristics ("Beschaffenheitsgarantie"). With respect to any examples or hints given herein, any typical values stated herein and/or any information regarding the application of the device, Infineon Technologies hereby disclaims any and all warranties and liabilities of any kind, including without limitation warranties of non-infringement of intellectual property rights of any third party.

Information

For further information on technology, delivery terms and conditions and prices please contact your nearest Infineon Technologies Office (www.infineon.com).

Warnings

Due to technical requirements components may contain dangerous substances. For information on the types in question please contact your nearest Infineon Technologies Office.

Infineon Technologies Components may only be used in life-support devices or systems with the express written approval of Infineon Technologies, if a failure of such components can reasonably be expected to cause the failure of that life-support device or system, or to affect the safety or effectiveness of that device or system.

Life support devices or systems are intended to be implanted in the human body, or to support and/or maintain and sustain and/or protect human life. If they fail, it is reasonable to assume that the health of the user or other persons may be endangered.